

# Small Squirrel Nest Box

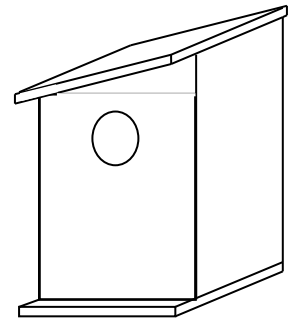

## Side

Eye bolts with chains and s-hooks mounted on each side are used to hang the nest box without harming the tree.

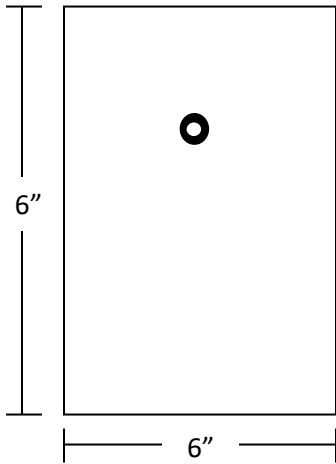

## Side

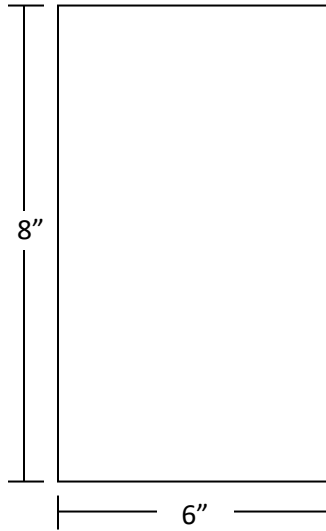

## Bottom

Drilled 3/16" holes for air circulation and drainage.

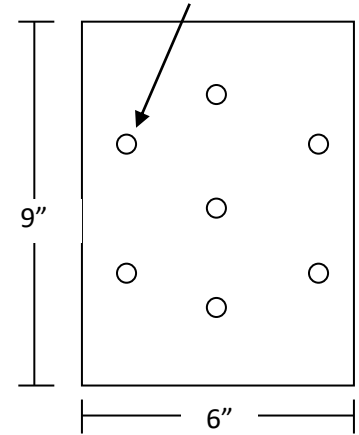

Overhang for small porch.

## Front/Back

A 2" ledge mounted just below the entrance hole on the inside allows baby squirrels easier accessibility and protects them from predators.

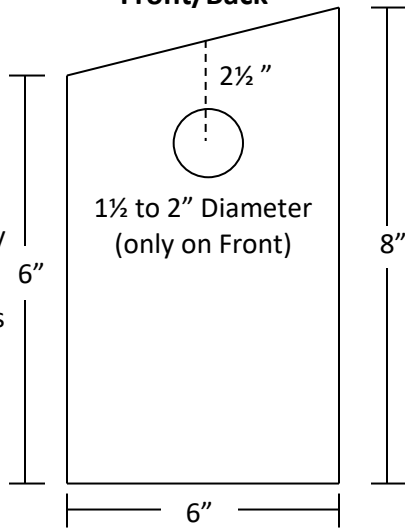

## Roof

Roof should be hinged with two 2" brass hinges to the taller side to allow for easy cleaning. Optional shingles provide extra drainage and protection.

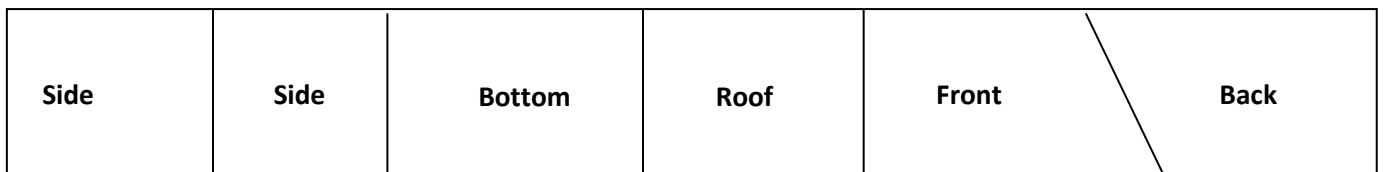
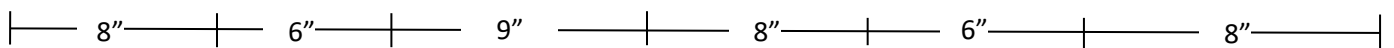
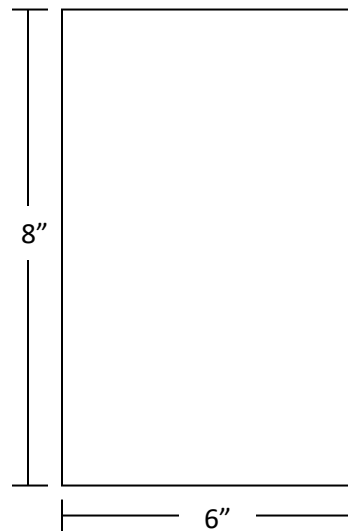

Use 1/2" plywood or untreated lumber